

New Dimension



Prezentovat se



Organizovat



Vyrábět

 www.compass-software.de

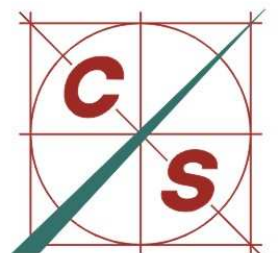

Compass Software

Správa dat



Podle objednávky

Integrace databáze

Editor formulářů

Asistent konstrukce

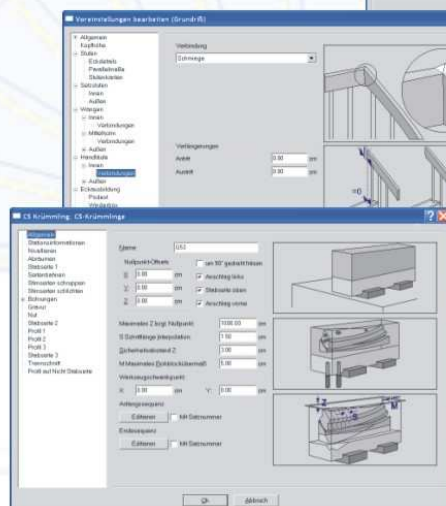
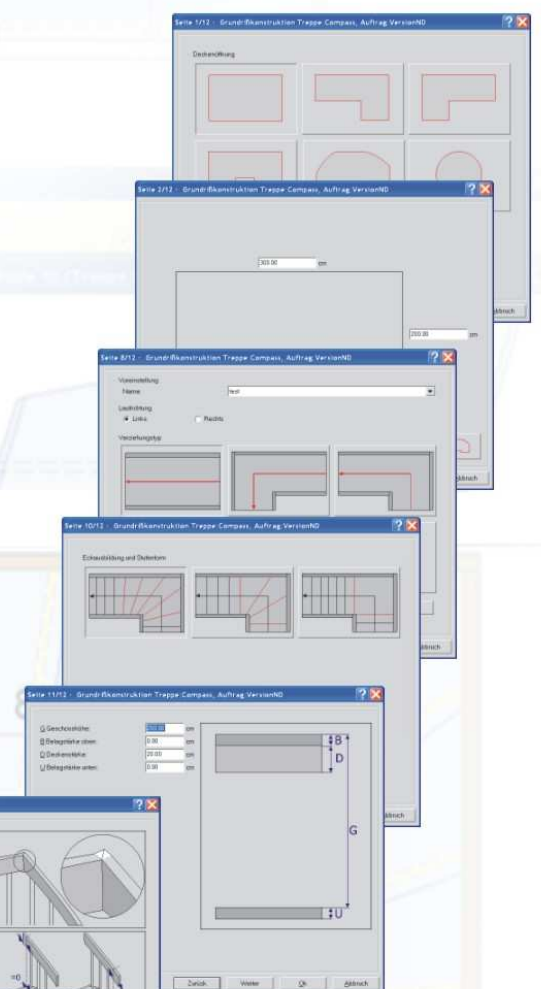
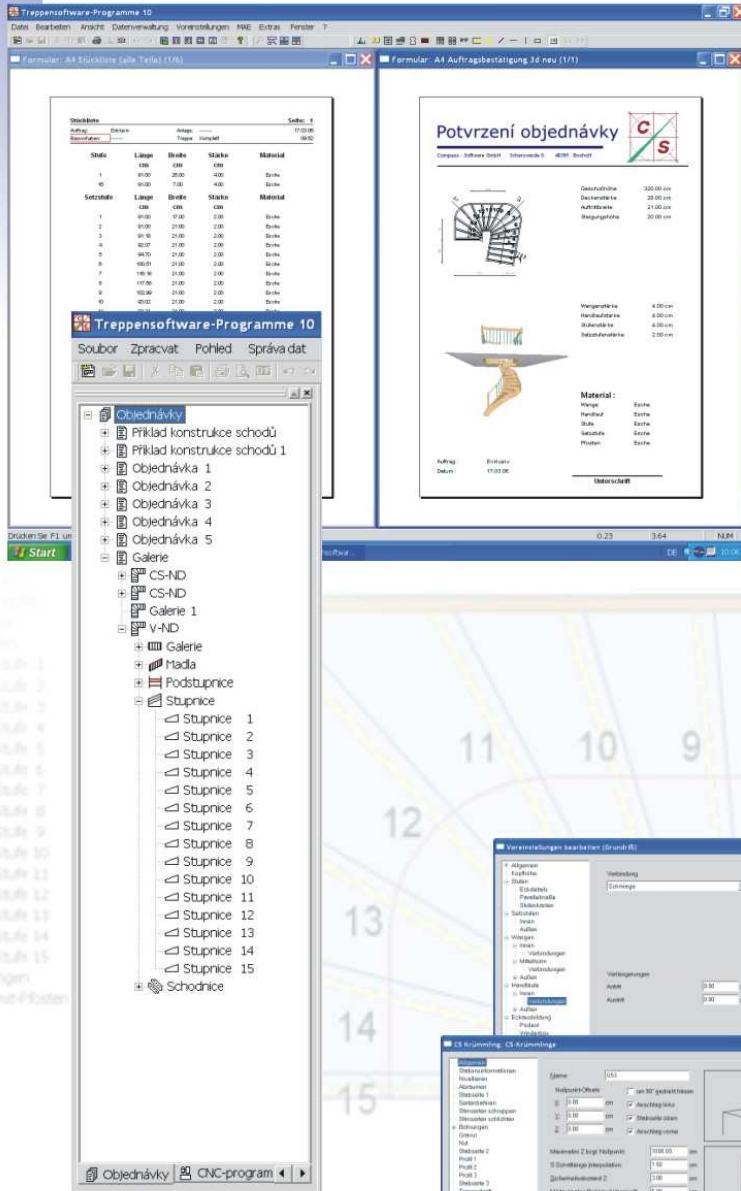
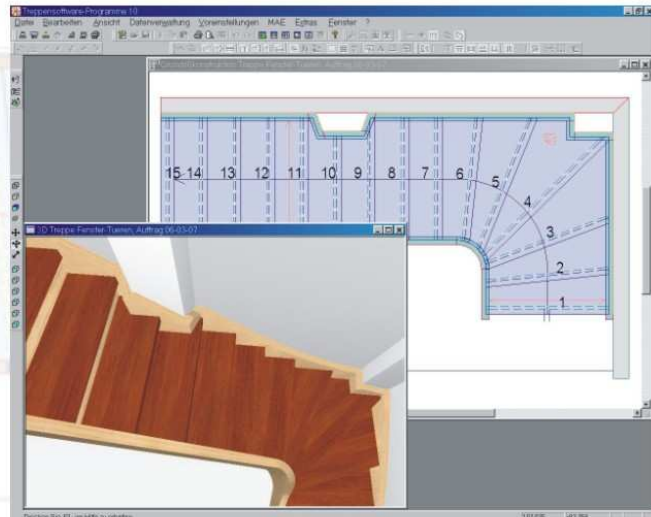

Konstrukční detaily



Vícepodlažné půdorysy libovolného tvaru

Napojení na galerii

Se stěnami, okny a dveřmi

Rozmanitost detailů

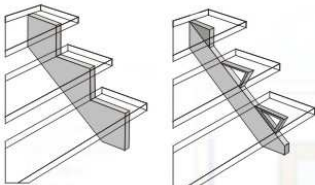
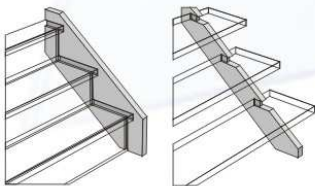
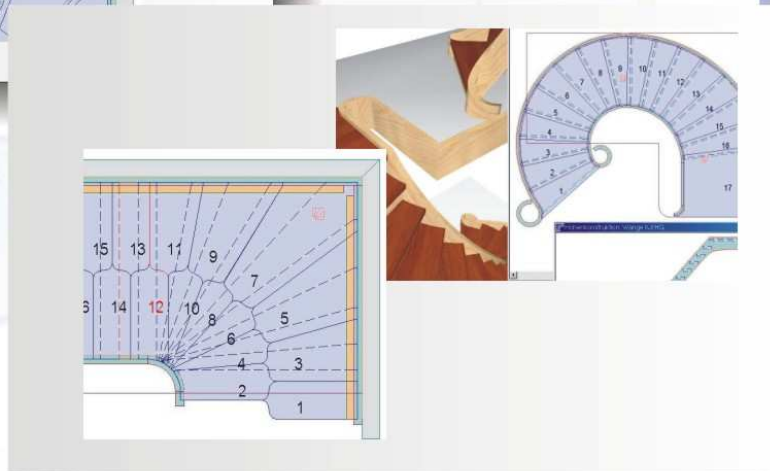
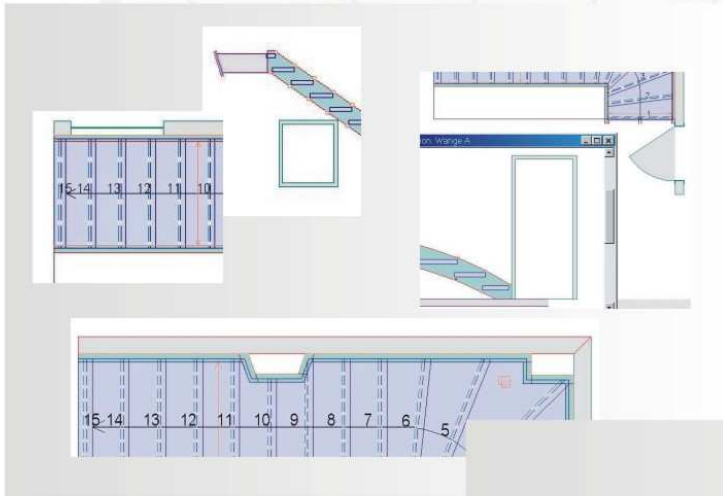

- ↖ Stair 1
- ↖ Stair 2
- ↖ Stair 3
- ↖ Stair 4
- ↖ Stair 5
- ↖ Stair 6
- ↖ Stair 7
- ↖ Stair 8
- ↖ Stair 9
- ↖ Stair 10
- ↖ Stair 11
- ↖ Stair 12
- ↖ Stair 13
- ↖ Stair 14
- ↖ Stair 15
- ↖ Wangan
- ↖ case and Pflaster
- ↖ Stair

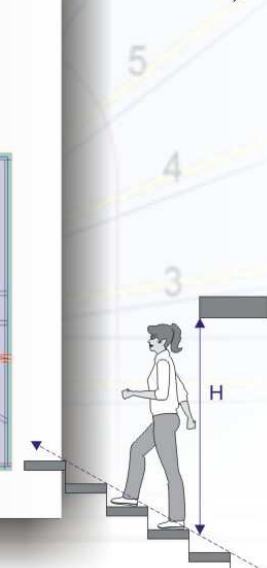
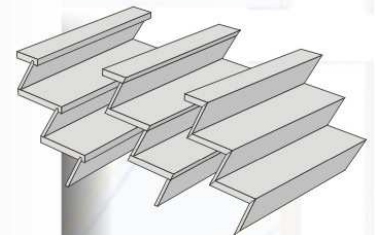
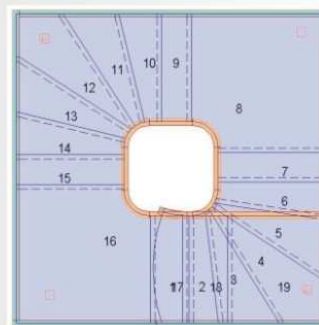
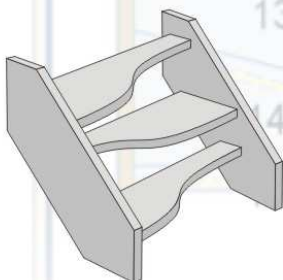



Vytvoření CAM-CNC

CAD

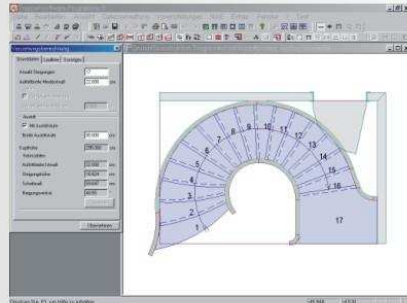

Přednastavení 3..n

Přednastavení 2

Přednastavení 1

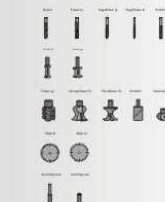

CAM - CNC

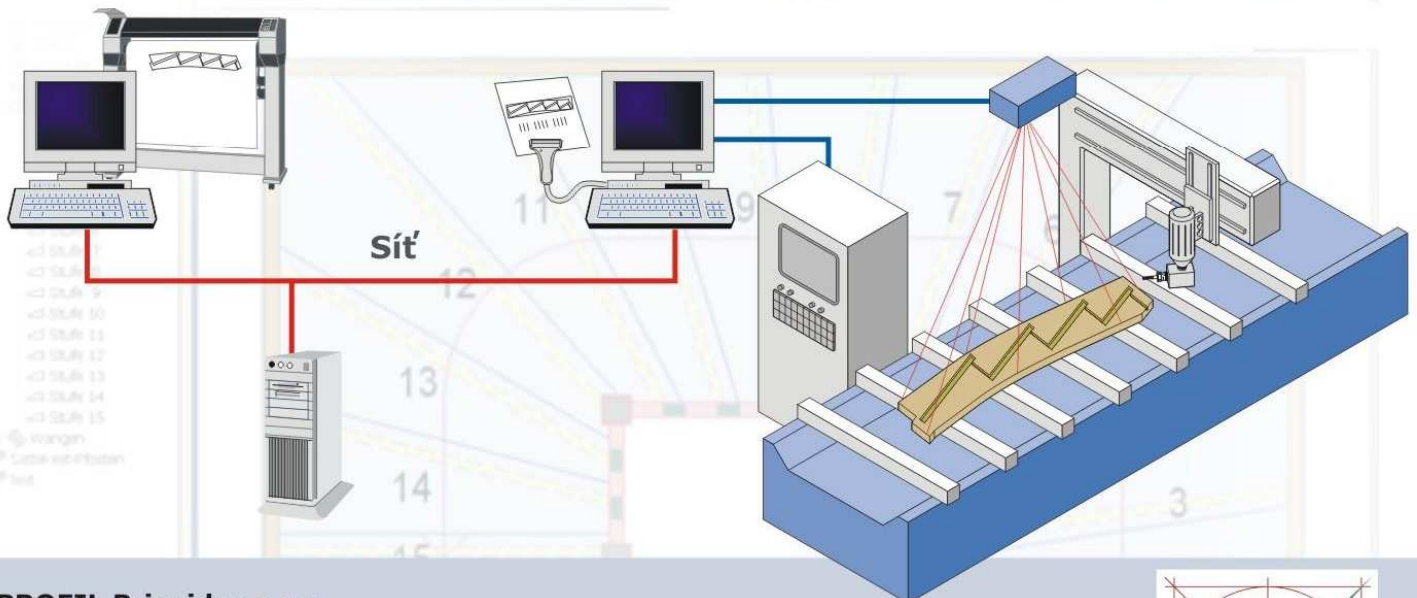
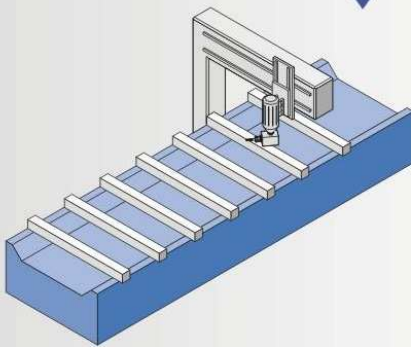

PROFIL Prievidza s.r.o.

Stúrova 1020/51
SK-972 13 Nitrianske Pravno
Tel.: (+42) 0 14 65 44 75 11
Fax: (+49) 0 14 65 44 75 11
Mail: profil@stonline.sk

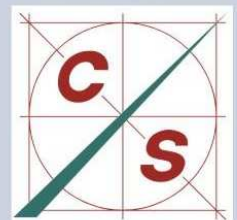

Některé ze zobrazených funkcí nejsou k dispozici v každé verzi